

THE FUTURE OF POWER

Trusted process solutions for a rapidly changing power industry.



Eastern
Controls

A man with a beard, wearing a yellow hard hat and a high-visibility yellow and black jacket, is shown in profile, looking down at a laptop computer. He is working in a dark environment, likely at night, with blurred lights in the background. The overall scene is illuminated with a mix of warm and cool tones.

INTRODUCTION

Since 1969, Eastern Controls has been your trusted partner in process measurement and control equipment across the Mid-Atlantic region.



POWER OFFERINGS 3

Control Valves

Masoneilan 4

Valves/Actuation

REXA 5

Auma / Conval 6

Gas and Flame Detection

MSA 7

Heat Trace

Raychem Chemelex /
O'Brien 8

Instrumentation

Endress+Hauser 9

SOR Controls Group 10

SERVICES 12

TRAINING 13

Headquartered in Edgemont, PA, with branches in Pittsburgh, PA, and Richmond, VA, we offer comprehensive support including engineering services, rapid response delivery, certified repair capabilities, and world-class training. Our strong partnerships with leading manufacturers enable us to deliver top-notch process control technologies, ensuring safe and reliable solutions.



POWER Offerings

Control Valves

Masoneilan

a Baker Hughes business

Severe Service Valves

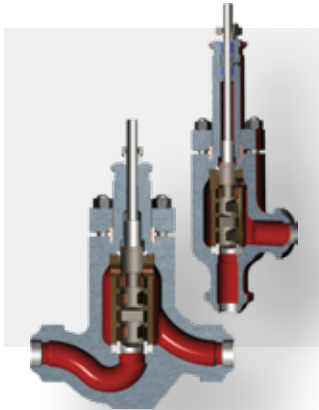

Power Applications:
Startup Feedwater Regulator, Feed Pump Recirculation, Superheater, Reheat, Turbine Bypass Attemperator Spray Water.

Lincoln Log

[SPECIFICATIONS →](#)



Power Applications:
Turbine Bypass, Export Steam Conditioning.

84000 Series Steamform

[SPECIFICATIONS →](#)

Rotary Control Valve

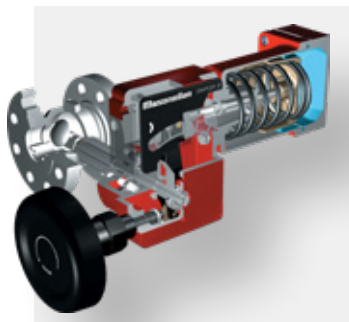

Power Applications:
Heater Drains, IP & LP Blowdown.

Camflex

[SPECIFICATIONS →](#)

Superheat Attemperator



Power Applications:
Boiler, Heat Recovery Steam Generator, Desuperheater.

DSH Series Desuperheater

[SPECIFICATIONS →](#)

Globe Control Valves



Power Applications:
Reliable, general-purpose valves for all plant types and Balance of Plant applications in 21K and 41K systems.

21000 & 41000 Series

[21000 SPECIFICATIONS →](#)

[41000 SPECIFICATIONS →](#)

Digital Valve Positioner



Power Applications:
All. The SVI3 is known as the Universal positioner for good reason!

SVI3

[SPECIFICATIONS →](#)

Valves/Actuation



Power Applications:
Turbine Bypass, Boiler Feedwater Regulator, Attemperators, Boiler Feedpump Recirculation, Inlet Guide Vanes.

Electraulic™ Actuation

(available in Linear, Rotary, and Damper Drive)

[SPECIFICATIONS →](#)

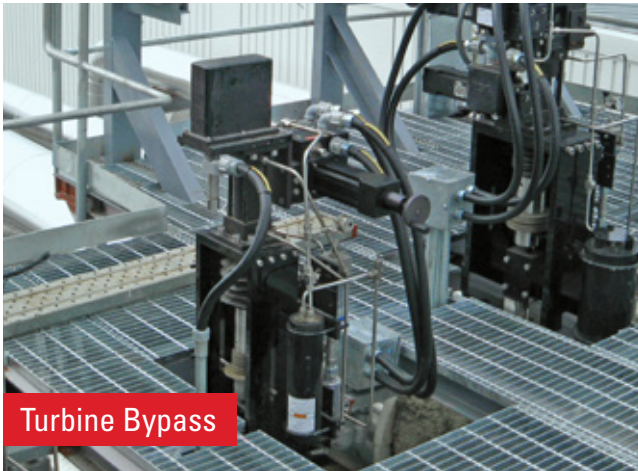

Turbine Bypass



Steam Turbine Governor Control



Feedwater Regulator



Turbine Bypass



Solutions for a world in motion

Multiturn



Power Applications:
All types of plants,
a wide variety of
applications.

SA

[SPECIFICATIONS →](#)

Quarterturn



Power Applications:
All types of plants,
a wide variety of
applications.

SQVEx

[SPECIFICATIONS →](#)



In-Line Rebuildable Ball Valve



Power Applications:
Ideal for Heat Recovery
Steam Generator
(HRSG) combined cycle
applications, such as:
isolation, vents, drains,
and feedwater.

Camseal

[SPECIFICATIONS →](#)

In-Line Rebuildable Globe Valve



Power Applications:
Used across the
power industry in
fossil fuel and nuclear
power plants in vent,
drain, blowdown, and
other applications.

Clampseal

[SPECIFICATIONS →](#)

In-Line Rebuildable Continuous Blowdown Valve

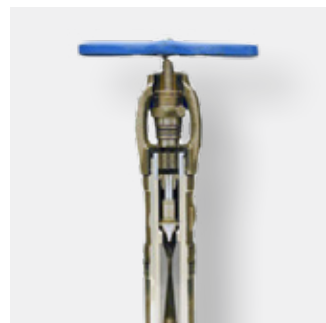

Power Applications:
Suitable for steam drains
or any high-pressure
letdown service.

Clampseal

[SPECIFICATIONS →](#)

Gas and Flame Detection Solutions



Power Applications: Combustion Turbine and Generator for natural gas and hydrogen detection.

Ultima X5000

[SPECIFICATIONS →](#)



Power Applications: Get continuous monitoring of methane, propane, and other combustible gases with this open-path infrared detector.

Ultima OPIR-5 Open Path Infrared Detector

[SPECIFICATIONS →](#)



Power Applications: An advanced multispectrum infrared (MSIR) flame detector that provides superior false alarm discrimination over long distances.

FL5000 MSIR Flame Detector

[SPECIFICATIONS →](#)

Heat Trace

Raychem

chemelox



Power Applications: Designed for freeze protection or process temperature maintenance of pipes and vessels up to 205°C continuously, with a maximum exposure temperature of 260°C.

HTV Self-Regulating Heat Cable

[SPECIFICATIONS →](#)



Power Applications:

For freeze protection of pipes and vessels that require steam cleaning and process temperature maintenance, up to 302°F/150°C.

XTVR Self-Regulating Heating Cable

[SPECIFICATIONS →](#)



Power Applications:

A mineral-insulated (MI) series resistance trace heating cables provide freeze protection and process temperature maintenance on pipes/vessels up to 1022 °F/ 550 °C and intermittent exposure to 1200 °F/650 °C.

MI Series Alloy 825 XMI-A HAx Heating Cable

[SPECIFICATIONS →](#)



Power Applications:

A range of compact, full-featured, touch-screen-based, single-point heat-tracing controllers, with ground fault protection. It provides control and monitoring for both freeze protection and process temperature maintenance.

Elexant 4010i Heat Trace Controller

[SPECIFICATIONS →](#)



Power Applications:

Heat Recovery Steam Generator, impulse tubing, steam and water sampling, transport, and chemical feed lines.

Pre-Insulated Tube Bundle

[SPECIFICATIONS →](#)

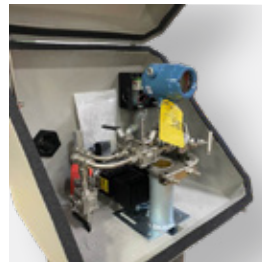

Power Applications:

All. Protects critical instruments from corrosion, chemical attack, mechanical abuse, weather, and freezing. A full range of sizes is available.

VIPAK® Enclosures

[SPECIFICATIONS →](#)

Instrumentation



Power Applications: Differential pressure transmitter with piezoresistive sensor and welded metallic membrane is used in all industries for continuous measurement in liquids, vapors and gases.

Deltabar S PMD75

[SPECIFICATIONS →](#)



Power Applications: Level guided wave radar for continuous level measurement in liquids under extreme conditions. The process connection, with its ceramic-graphite seal, safeguards high-temperature and high-pressure applications as they occur in steam boilers. For HP, IP and LP Drum Level Control.

Levelflex FMP54

[SPECIFICATIONS →](#)



Power Applications: The digital all-around ORP sensor measures reliably even in harsh applications or hazardous areas. Designed for low maintenance and a long operating life, it features Memosens 2.0 digital technology, providing the perfect basis for predictive maintenance due to its extended storage of calibration and process data.

Memosens CPS12E

[SPECIFICATIONS →](#)



Power Applications: Transmitter with the ability to connect up to 4 Memosens sensors of your choice from over 12 measurement parameters. It offers automatic sensor recognition, flexible expandability, and standardized spare parts with all other devices of the Liquiline platform. Typically used in drain and blowdown applications.

Liquiline System CA80SI

[SPECIFICATIONS →](#)



*Available in Western PA, Virginia, West Virginia, and Ohio only.



Power Applications:
Magnetic Level Indicator for Feedwater Heater Level or Condenser Hotwell Level.

1100 Series

[SPECIFICATIONS →](#)



Power Applications:
Hermetically sealed pressure switch applications are utilized all over power plants.

Big Hermet/Mini Hermet

[SPECIFICATIONS →](#)





POWER

Through Outage Season & Beyond

SERVICES

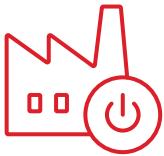

Outage/Plant
Shutdown
Services



Start-Up &
Commissioning



Diagnostic,
Repair, and
Calibration
Services



24/7 Emergency
Services

Authorized Service Center

Endress+Hauser 
People for Process Automation

 **MARC**

The Safety Company

auma[®]
Solutions for a world in motion

ELECTRAULIC™ ACTUATION

TRAINING

All of our core courses are held on-site at the Eastern Controls facility in Edgemont, PA where we provide both classroom theory and hands-on lab training in our state-of-the-art Process Training Unit[®] (PTU[®]), a full-scale, fully-functional process plant. Plan your training schedule by selecting your desired courses from the Course Calendar in the Course Registration section. For more information about any course, click the course title in the Course Details section.



Control Valve Fundamentals



Fundamental Instrumentation



Instrumentation II – Level & Pressure



Heat Trace



Electrical Safety in the Workplace



Customized Training Courses



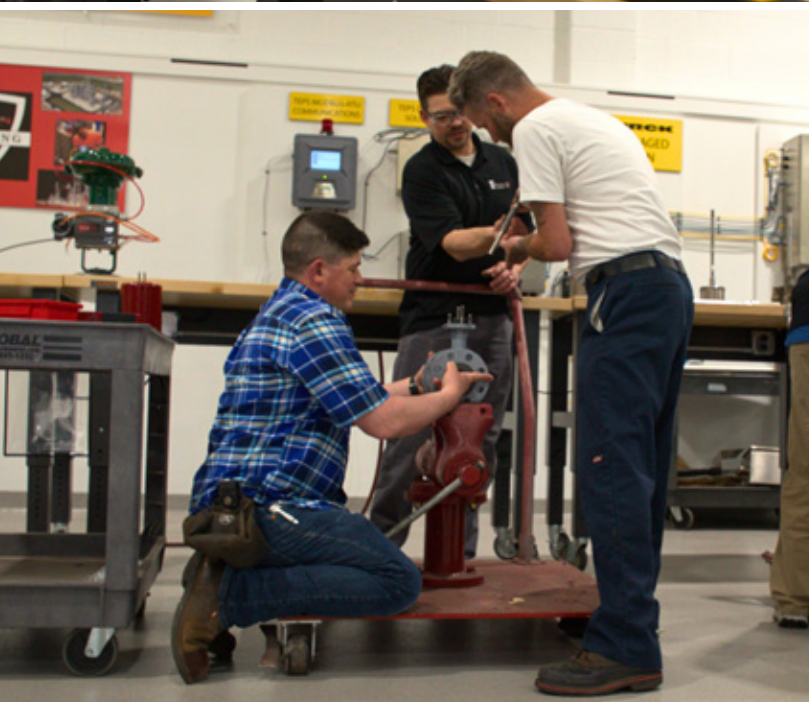

OPENING 2026

New Eastern Controls Headquarters



GEOGRAPHIES WHERE EASTERN CONTROLS OPERATES:

- Pennsylvania
- Delaware
- New Jersey
- NYC Metro
- Maryland
- Washington, D.C.
- Virginia
- West Virginia
- Ohio

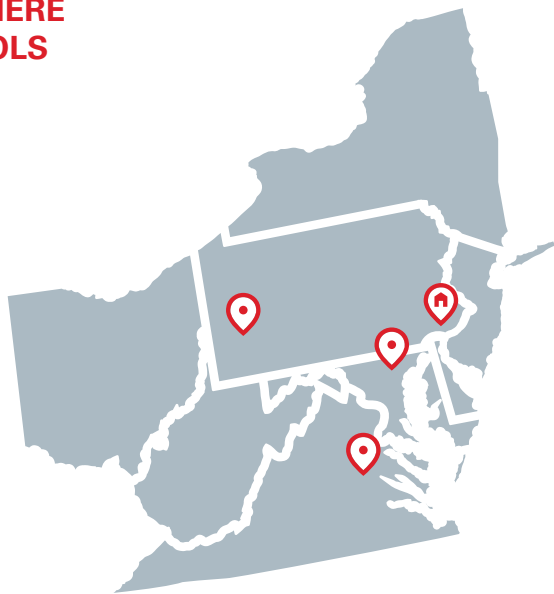

The **Eastern Controls Demo Truck** provides customers with the unique opportunity to experience live, in-person product training and demonstrations. Our mobile, hands-on demo experience was designed to enhance your team's technical skills and knowledge, bringing it right to your plant's front door!

Discover how the latest control valve and actuation solutions from **Masoneilan Control Valves**, **REXA, Inc.**, and **Conval** can meet your most challenging process control demands.

Interested in bringing the Demo Truck to your plant or facility? **Complete this form**, and a sales rep will be in touch to coordinate.



*Demo Truck dates are subject to availability.



EasternControls.com



SALES
(610) 325-4600
sales@easterncontrols.com

SUPPORT (24/7)
(866) 566-9820
servicerfq@easterncontrols.com